

# PGFM3000 Series

Standard motorised faders

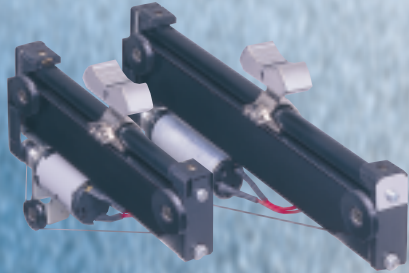

Style one

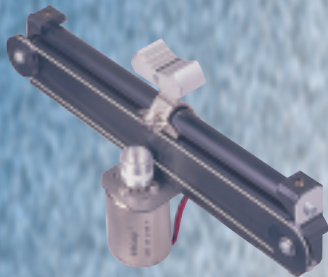

Style two

The motorised PGFM3000 Series range of professional faders are available in a variety of configurations and output laws. They are designed to offer a versatile solution for all space envelopes coupled with rapid dynamic response, high accuracy and repeatability.

- 65mm 104mm stroke lengths
- two motor mounting styles
- touch sense path
- mono/stereo audio or VCA options
- internal track switch options
- external microswitch options

## SELECT THE FADER OPTIONS YOU REQUIRE

Stroke length	65mm <sup>0</sup>	104mm <sup>2</sup>	
Output law	Servo only <sup>00</sup>	Linear <sup>10</sup>	Log audio taper <sup>20</sup>
	Stereo log audio taper <sup>22</sup>	VCA <sup>60</sup>	
Fader type	series PGFM3	stroke	law
Please enter the codes for the first two options. This will identify the fader data shown opposite			
Resistance ±20%	5kΩ <sup>C</sup>	10kΩ <sup>D</sup>	VCA2k7Ω <sup>E</sup>
Mounting threads	M3 <sup>M</sup>	4-40 UNC <sup>U</sup>	

## Switch options

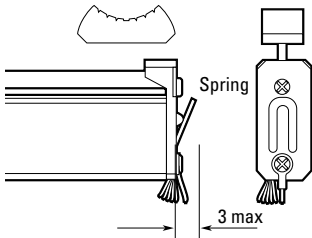

### Pre-fade listen

The switch operates before the active track is reached. This is at the infinity end of the fader and is always under spring load. Spring returns switch to off when knob is released.

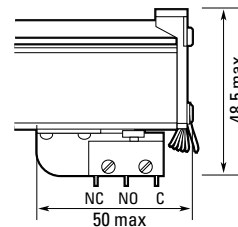

### Fader start/Auxiliary

The switch operates within 4mm from the mechanical stop at the infinity end of the fader and can be microswitch or track switch based.

**Note:** For external microswitch Pre-fade listen option refer to those dimensions given under Fader start/Auxiliary added to that given under Pre-fade listen.

- |  |                          |   |
|--|--------------------------|---|
| Internal pre-fade listen track switch (2mA max)              | <input type="checkbox"/> | - |
| 1st internal track switch (2mA max) fader start/auxiliary    | <input type="checkbox"/> | - |
| External microswitch (100mA max) fader start/auxiliary 1 off | <input type="checkbox"/> | A |
| External microswitch (100mA max) fader start/auxiliary 2 off | <input type="checkbox"/> | B |
| External microswitch (100mA max) pre fade listen (see note)  | <input type="checkbox"/> | O |

Only one switch option per column to be selected

### Track switch

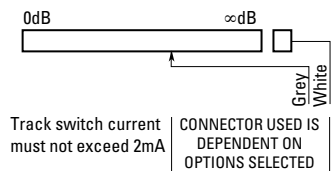

# Dimensions and knob bracket options

## Style one

Stroke length	A	65	104
Mounting centres	B	80	120
Length	C	97	137
Mounting to datum	E	7.5	8

All dimensions shown in mm

### Drive motor data

Motor supply	12Vd.c.
Stall current	0.54A
Typical power consumption	1.2W

It is important that the fader slider is NOT driven against the end stops.

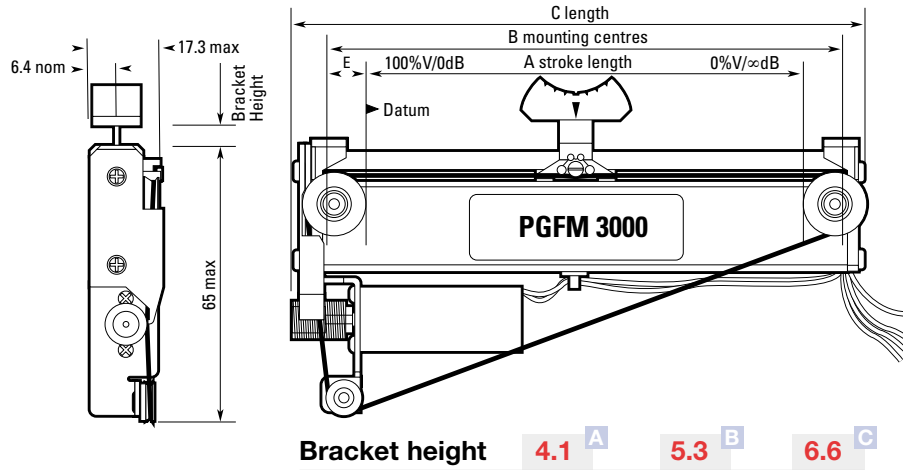

Bracket height **4.1** **A** **5.3** **B** **6.6** **C**

## Circuit diagrams/Terminations for Style one

### Servo track - all fader types

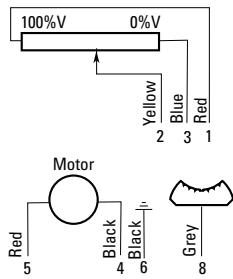

### Fader types - M3010 • 3020 • M3060 • M3210 • M3260

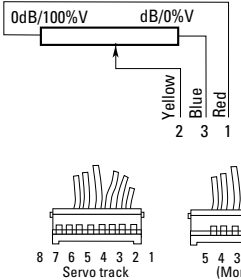

### Fader type stereo - M3022

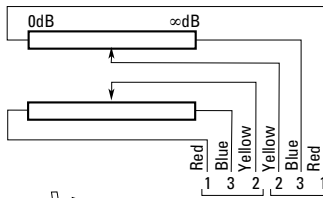

### Fader type mono - M3220

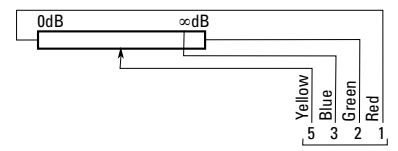

### Fader type stereo - M3222

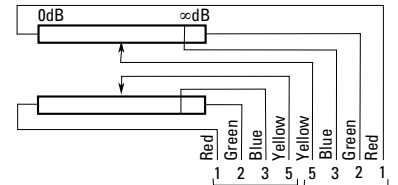

Connectors IDC Molex series 7720S female.  
Cable lengths 100 ±10mm.

## Style two

Stroke length	A	65	104
Mounting centres	B	80	120
Length	C	109	137
Mounting to Datum	E	7.5	8

All dimensions shown in mm

### Drive motor data

Motor supply	12Vd.c.
Stall current	0.57A
Typical power consumption	1.2W

It is important that the fader slider is NOT driven against the end stops.

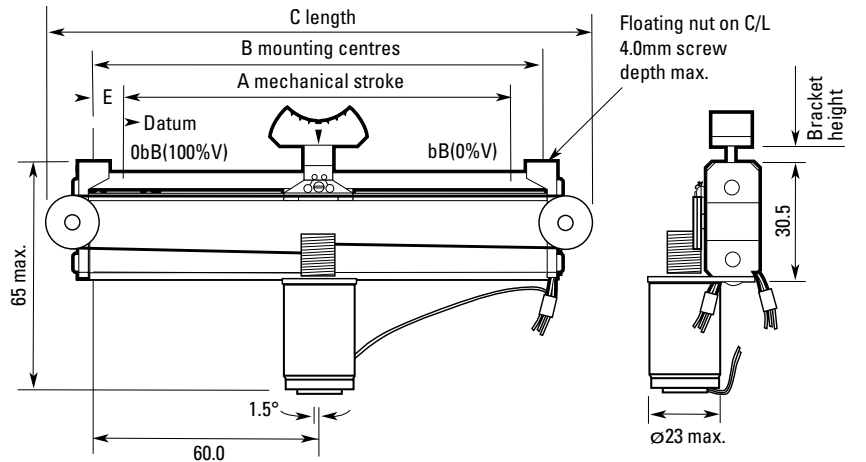

Bracket height **4.1** **A** **5.3** **B** **6.6** **C**

## Circuit diagrams/Terminations for Style two

### Servo track - all fader types

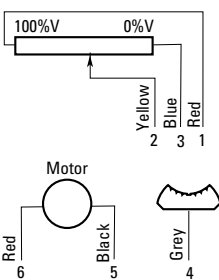

### Fader types - M3010 • M3020 • M3060 • M3220 • M3260

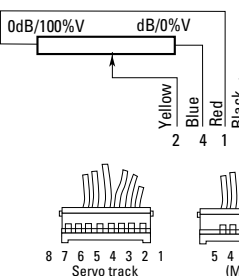

### Fader type stereo - M3022

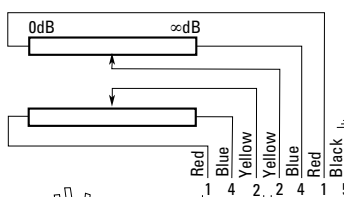

### Fader type mono - M3220

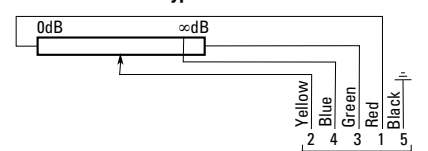

### Fader type stereo - M3222

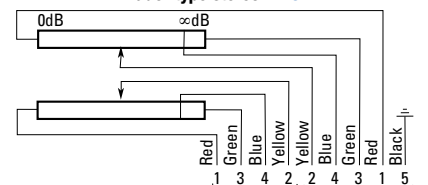

Connectors IDC Molex series 7720S female.  
Cable lengths 100 ±10mm.

## Output law characteristics

### Servo track

<b>Resistance</b>	10kΩ ±20%
<b>Resistance for stereo faders with 10kΩ audio track</b>	40kΩ ±30%
<b>Linearity - independent</b>	±2%
Mono	±3%
Stereo	±3%

The electrical length of the servo track is longer than the mechanical stroke of the fader so that 0%V and 100%V are never achieved. The maximum and minimum voltages are 99.7mV and 0.25mV respectively. (1V reference)

<b>Touch Sense resistance</b>	<300Ω
-------------------------------	-------

### VCA

Refer to Penny+Giles for laws other than standard

Type	Slider travel (mm)	% Output	% Tolerance	Type	Slider travel (mm)	% Output	% Tolerance
M3060	0	100	-0.1	M3260	0	100	-0.1
	9.0	95	±3.0		12.5	95	±2.0
	17.0	90	±3.0		24.4	90	±2.0
	26.2	85	±3.0		38.9	85	±2.0
	32.8	80	±3.0		50.6	80	±2.0
	41.3	70	±3.0		64.0	70	±3.0
	49.0	60	±5.0		76.2	60	±3.0
	65.0	0	+0.1		88.7	50	+3.0
					94.4	40	±5.0
					100.1	30	
			104.0	0	+0.1		

### Log audio taper

Maximum insertion loss 1.0dB. Typical input-related crosstalk 100dB

Type	Accuracy	Matching accuracy relative to track one	Cut off
M3020 M3022	±2.0dB (0-30)	±2.0dB (0-30)	85dB
M3220	±1.0dB (0-20)	-	100dB
M3222	±2.0dB (21-40)	±1.0dB (0-40)	

### Linear

Maximum end Volts 0.1%

Type	Accuracy
3010	±3%
3210	±2%

**Test conditions:** • wiper load 100kΩ log only • element resistance 10kΩ • frequency for cut-off 15kHz • frequency for law accuracy 1kHz

## Panel Graduations/Slots

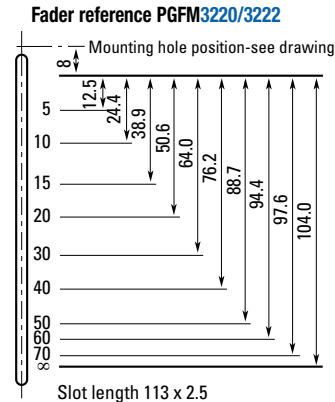
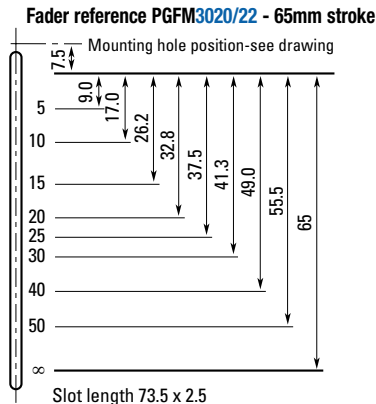

## Fader knob options



Faders are fitted with a 11mm satin finish chrome knob as standard. An 11mm bright chrome finish is available as an option.

## TO ORDER OR OBTAIN A QUOTATION Please contact your nearest sales office and advise:

The series number and description, the stroke length, output law, resistance, fixing threads, switches and bracket height.

**For example** • PGFM3000 • slimline fader • 104mm stroke • VCA • one channel • VCA2k7Ω • fixing threads 4-40 UNC • internal pre-fade listen • 6.6mm bracket height. Penny+Giles would code this fader as:

	series	stroke	law	resistance	inserts	switches	bracket	special
Fader type	M3	2	60	/ E /	U /	O - /	C /	